

 **PAPER
PLUSHIES™** FAN ART

THE CHILD



©2020 by David Landis • All rights reserved. Published by Landis Productions. Paper Plushies and associated logos are trademarks of Landis Productions and this project is not intended for resale • www.landisproductions.com • When a Paper Plushies craft is classified with the term "fan art" it means that the material presented consists of my original illustration and papercraft engineering but it is inspired by products and/or characters that I did not invent.



PRINT, BUILD, SHARE!

PAPER PLUSHIES are a new breed of free paper craft projects by Landis Productions. I invite you to download, print, build, and share them with you friends!



TAKE A PHOTO!

Snap a photo of your completed project and share it on your favorite social network with a fun description and hashtag **#paperplushies** in the caption!



WANT MORE?

Get free paper craft in your **INBOX!** Subscribe to my newsletter at **PAPERPLUSHIES.COM** today!

GRAPHIC ARTS NEWSLETTER BY LANDIS PRODUCTIONS

**CREATIVE
MUSCLE**
MONTHLY

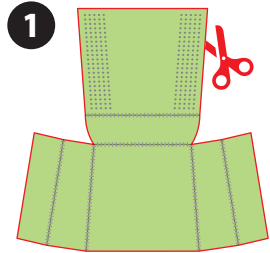

1
Carefully cut out the front piece with scissors.

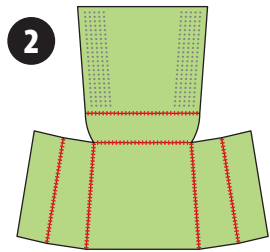

2
Fold the shape on all the stitch lines to create creases, then flatten out again.

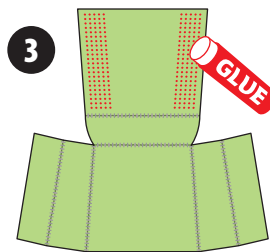

3
Using a glue stick, apply glue on these dotted areas.

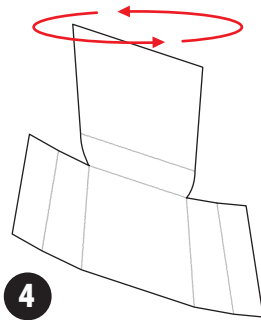

4
Pick the piece up and turn it over to its blank side. You should be able to see the crease indentions from step 2.

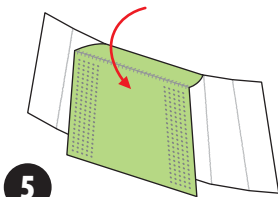

5
Fold over the center panel along your pre-made creases.

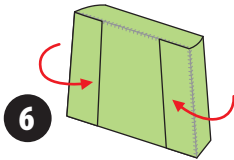

6
Fold over the side flaps and affix to glued areas, being mindful not to crush the boxy shape of the front piece.

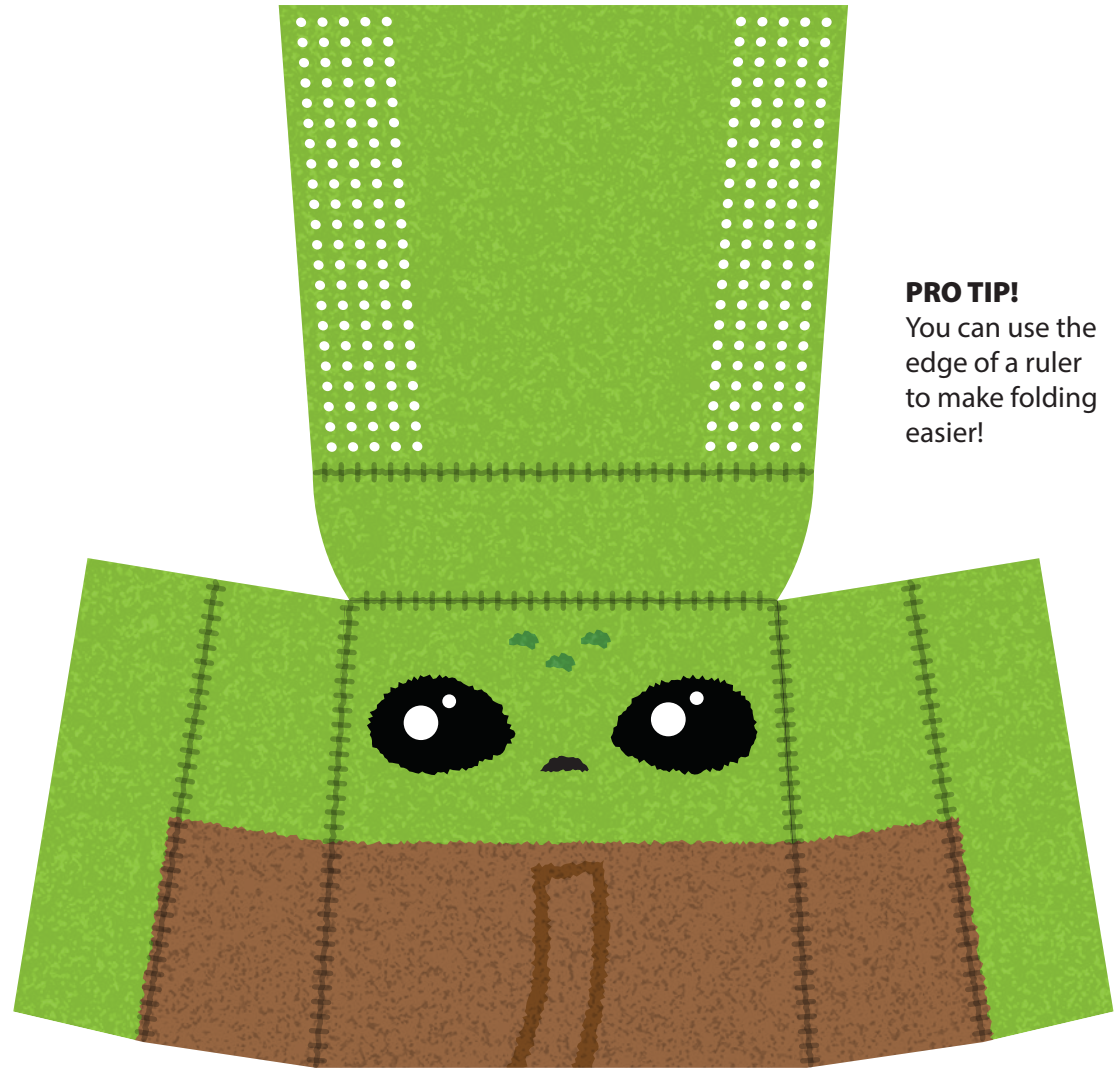

PRO TIP!
You can use the edge of a ruler to make folding easier!

FRONT PIECE

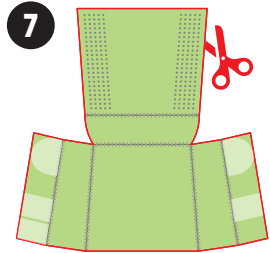

7
Carefully cut out the back piece with scissors.

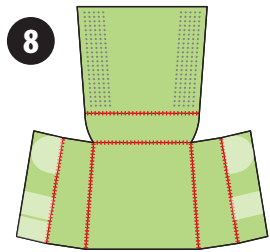

8
Fold the shape on all the stitch lines to create creases, then flatten out again.

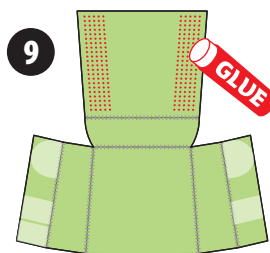

9
Using a glue stick, apply glue on these dotted areas.

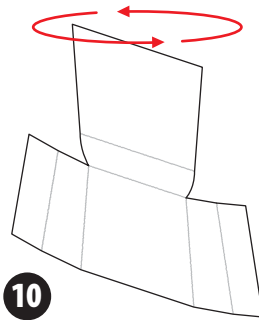

10
Pick the piece up and turn it over to its blank side. You should be able to see the crease indentions from step 2.

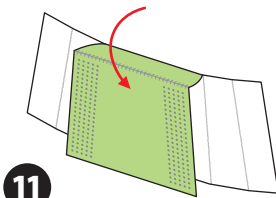

11
Fold over the center panel along your pre-made creases.

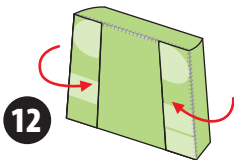

12
Fold over the side flaps and affix to glued areas, being mindful not to crush the boxy shape of the back piece.

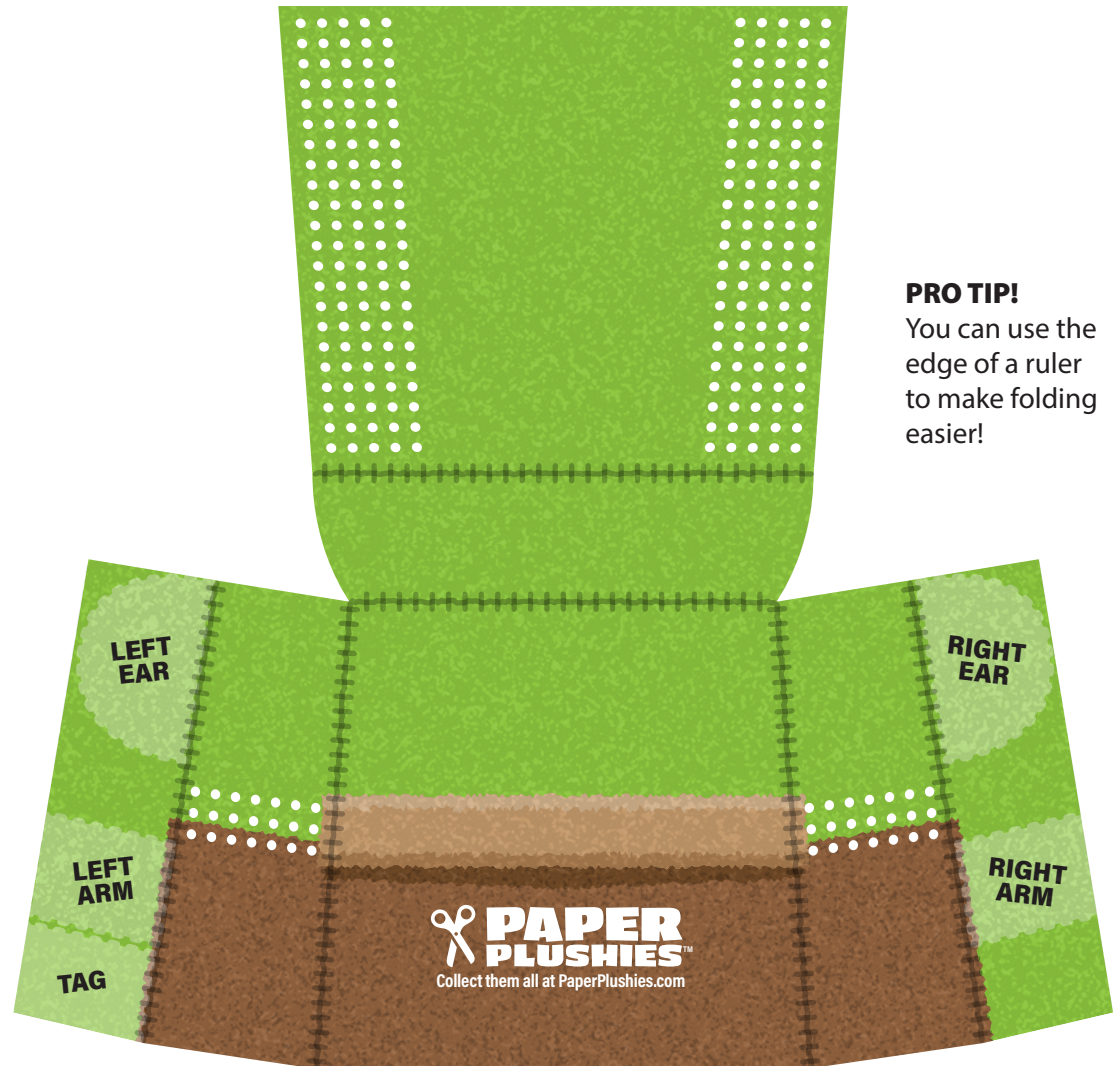

PRO TIP!
You can use the edge of a ruler to make folding easier!

BACK PIECE

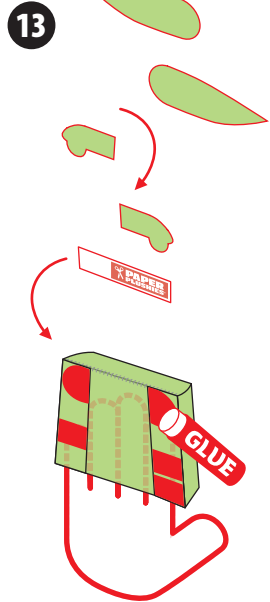

Carefully cut out the accent pieces with scissors. Glue the accent pieces to the back piece where indicated using the words to match things up.

PRO TIP!

You can slide the back piece over your hand like a mitten to make gluing easier!

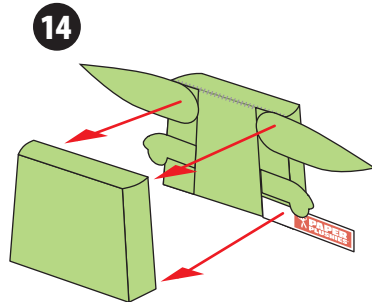

Next add glue to the interior sides of the front and back pieces and "sandwich" them together.

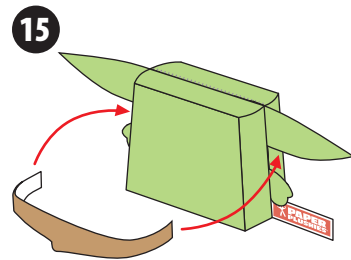

The final step is to add glue to the collar piece and glue in place so it wraps around the front of the of the paper craft to form your completed Paper Plushies masterpiece!

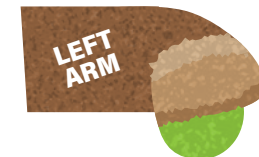
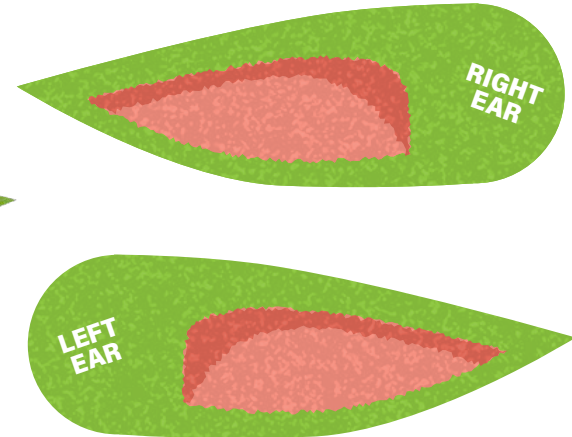

PRO TIP!

Cut this page into easy-to-handle chunks before doing your fine-tune trimming of each accent piece.

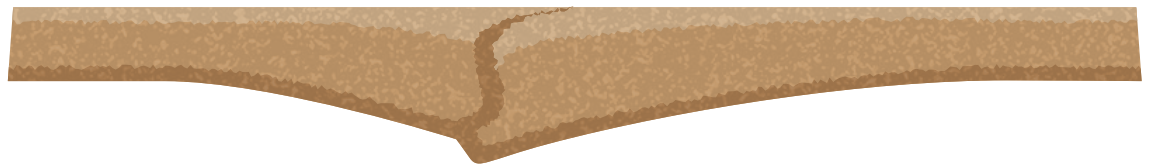

If you enjoyed this free project, you'll love these paper craft books!

Papercuttables

Build 15 unique Papercuttables, and become a crafty participant in an exciting action-packed story! Race against time in order to save your creations from a dark and mysterious force set out to destroy the land of the Papercuttables once and for all!

Papercuttables is an 80-page paper craft book by David Landis and published by SCHOLASTIC – the largest publisher of children's books in the world!



papercuttables.com



Desktop Gremlins Vol. 1

Build 20 astounding paper sculptures! Desktop Gremlins are paper craft monsters, mischief-makers and magical creatures that are easy to build, fun to display, and awesome to share! Each character has a different story and extraordinary reasons to be sitting on your desk.

Desktop Gremlins is a 96-page paper craft book by David Landis.

desktopgremlins.com

Learn more at landisproductions.com

